

Angle Bottleneck Option

Specified in part number

-AB“Angle”x“Height”

Example:

For an angle bottleneck 10° x 0.012 inch high,
 specify “-AB10x12”
 Also available in 5°, 15°, and other angles.

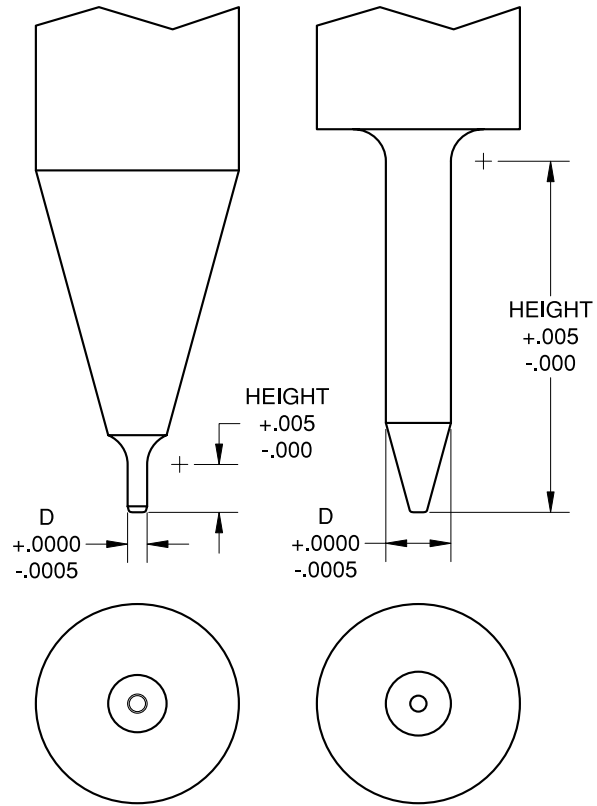

Straight Bottleneck Option

Specified in part number

-SB“D”x“Height”

Example:

For a straight bottleneck
 0.009 inch diameter x 0.015 inch high,
 specify “-SB9x15”

“D” must be at least 0.0010 inch greater than
 the capillary “T” dimension.

See bottleneck design table for design constraints.

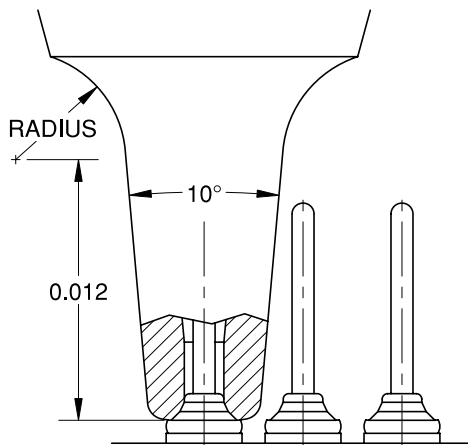

Specifying an Angle Bottleneck

In part number:
-AB10x12

Dimensions in inches unless otherwise specified

STRAIGHT BOTTLENECK DESIGN TABLE		
SB D DIMENSION in./µm	MAXIMUM H DIMENSION .375 LENGTH in./µm	MAXIMUM H DIMENSION .437 LENGTH in./µm
.005/127	N/A	N/A
.006/152	.007/178	.007/178
.007/178	.010/254	.010/254
.008/203	.015/381	.015/381
.009/229	.020/508	.020/508
.010/254	.025/635	.025/635
.011/279	.032/813	.032/813
.012/305	.038/965	.038/965
.013/330	.044/1118	.044/1118
.014/356	.044/1118	.044/1118
.015/381	.044/1118	.048/1219
.016/406	.050/1270	.058/1473
.020/508	.072/1829	.120/3048
.025/635	.110/2794	.180/4572
.030/762	.180/4572	.220/5588

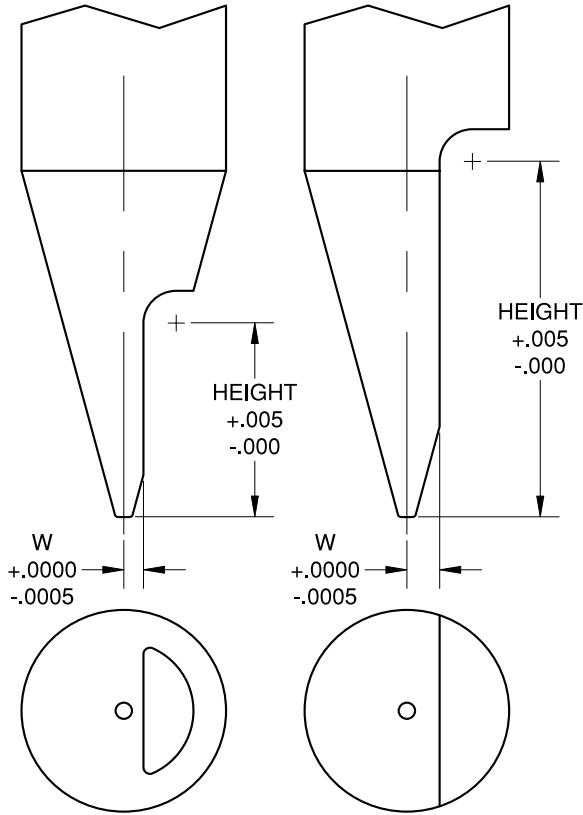

Single Side Relief Option

Specified in part number

-SR“W”x“Height”

Note: Relief may cut into capillary core.

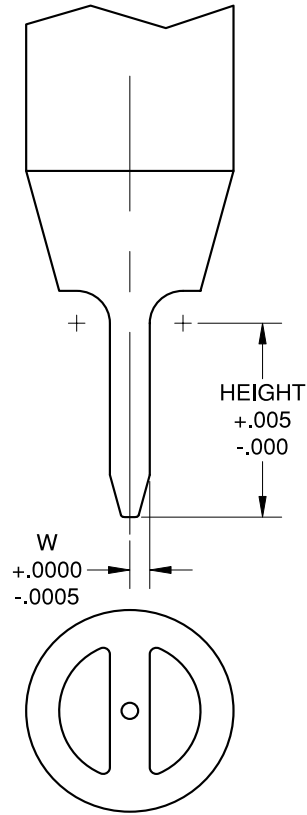

Double Side Relief Option

Specified in part number

-DR“W”x“Height”

Note: Relief may cut into capillary core.
 See DR design table for design constraints.

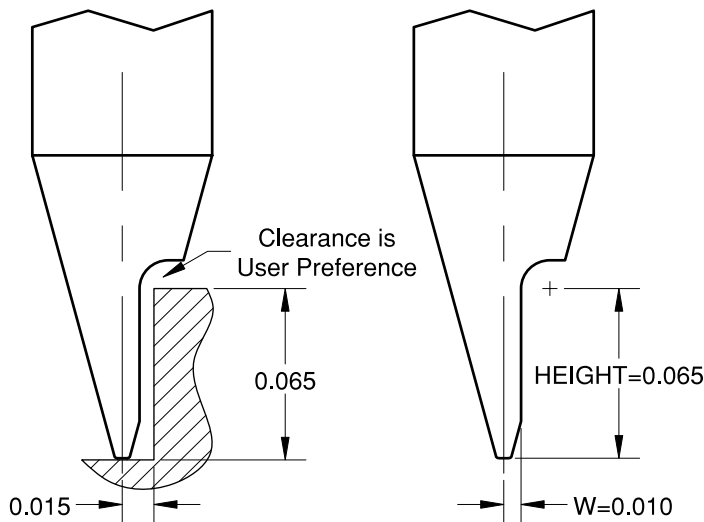

Specifying a Side Relief

In part number:

-SR10x65

Dimensions in inches unless otherwise specified

DOUBLE SIDE RELIEF DESIGN TABLE		
DR OPTION W DIMENSION in./µm	MAXIMUM H DIMENSION .375 LENGTH in./µm	MAXIMUM H DIMENSION .437 LENGTH in./µm
.0025/64	N/A	N/A
.0030/76	.007/178	.007/178
.0035/89	.010/254	.010/254
.0040/102	.015/381	.015/381
.0045/114	.020/508	.020/508
.0050/127	.025/635	.025/635
.0055/140	.032/813	.032/813
.0060/152	.038/965	.038/965
.0065/165	.044/1118	.044/1118
.0070/178	.044/1118	.044/1118
.0075/191	.044/1118	.048/1219
.0080/203	.050/1270	.058/1473
.0100/254	.072/1829	.120/3048
.0125/318	.120/3048	.190/4826
.0150/381	.190/4826	.230/5842